



HAL
open science

Modelling of Quasi-Optical Systems: Application to Skin Spectroscopy

Gregory Gaudin, Alain Peden, Daniel Bourreau, Clément Henry

► **To cite this version:**

Gregory Gaudin, Alain Peden, Daniel Bourreau, Clément Henry. Modelling of Quasi-Optical Systems: Application to Skin Spectroscopy. EuCAP 2025: 19th European Conference on Antennas and Propagation, Mar 2025, Stockholm, Sweden. pp.1-4, <10.23919/EuCAP63536.2025.10999502>. <hal-05298739>

HAL Id: hal-05298739

<https://imt-atlantique.hal.science/hal-05298739v1>

Submitted on 13 Nov 2025

HAL is a multi-disciplinary open access archive for the deposit and dissemination of scientific research documents, whether they are published or not. The documents may come from teaching and research institutions in France or abroad, or from public or private research centers.

L'archive ouverte pluridisciplinaire HAL, est destinée au dépôt et à la diffusion de documents scientifiques de niveau recherche, publiés ou non, émanant des établissements d'enseignement et de recherche français ou étrangers, des laboratoires publics ou privés.



Distributed under a Creative Commons CC BY-NC-ND 4.0 - Attribution - Non-commercial use - No Derivative Works - International License

Modelling of Quasi-Optical Systems: Application to Skin Spectroscopy

Gregory Gaudin^{*†‡}, Alain Peden^{*†}, Daniel Bourreau^{*†}, Clément Henry^{*†}

^{*}IMT Atlantique, Brest, France

[†]Lab-STICC, UMR CNRS 6285, Brest, France

[‡]gregory.gaudin@imt-atlantique.fr

Abstract—This work presents a simulation pipeline for modelling quasi-optical systems and demonstrates its potential as a transfer function for permittivity extraction at terahertz (THz) and sub-terahertz (sub-THz) frequencies. The simulated transfer function is validated against oblique reflection measurements and compared to the conventional plane wave approximation. Numerical results also show the application of this simulation tool to the modelling of a skin continuous-wave (CW) spectrometer.

Index Terms—quasi-optical system, free space measurement method, skin permittivity, Gaussian beam, field expansion, beam tracing.

I. INTRODUCTION

Terahertz (THz) and sub-terahertz (sub-THz) waves are gaining more and more interest for a wide range of applications, including non-destructive testing, telecommunications and bio-sensing. Their high sensitivity to water content and non-ionising properties make them suitable for the diagnosis of skin related conditions. To properly operate, skin sensing techniques require the retrieval of skin complex permittivity through skin spectroscopy.

THz and sub-THz skin permittivity extraction, whether it operates in time domain (TD) [1] or with continuous wave (CW) [2] is generally based on quasi-optical systems leveraging focused Gaussian beams. To map the spectrometer measurements to the relevant skin parameters, it is required to minimise the error between real measurements and synthesised data generated through a skin model's transfer function. It is crucial for this transfer function to mimic precisely the quasi-optical system to guarantee the correctness of the permittivity retrieved.

Usually, both TD and CW spectroscopy methods rely on the plane wave (PW) approximation, using Fresnel formulas for transmission and reflection as transfer function [1], [3]. This approximation yields a good accuracy when the electrical size of the Gaussian beam (GB) waist interacting with the sample is large [2], [3], [4], however it introduces a non negligible error when the GB is strongly focused [4] or under oblique incidence [5]. For this reason, a more precise transfer function is required when retrieving localised skin permittivity values, since highly focused GB under oblique incidence are generally employed in this scenario [1].

A compensation method was introduced in [6], which corrects the plane-wave transfer function by incorporating the Gouy phase term originating from the focused GB. The same

authors also proposed mechanical compensation in a TDS setup as an alternative [7]. Another strategy involves using a transfer function based on the propagation in transmission of reflection of a fundamental Gaussian beam instead of a PW [5], [8]. These approaches not only capture the GB-sample interaction but also accounts for the quasi-optical setup potential misalignments.

However, these methods assume ideal optical components (such as lenses and mirrors) and a perfect Gaussian beam at emission, which prevents modeling the uncertainties in the real setup. To remedy this, we propose here to employ a transfer function based on the simulation the entire spectrometer. The fast simulation is enabled by an asymptotic electromagnetic modelling tool, that we have presented in [9], and employed for modelling CW measurement benches operating in the sub-THz bands with electrically large GB waist and normal incidence [9], [10].

We first recall our modelling pipeline, which enables the use of a simulated transfer function (i.e., mapping the sample's parameters to simulated S-parameters). Then, we provide results showing the limitations of the plane wave (PW) approximation for oblique measurements in a setup with a large spot size. Finally, we present some preliminary numerical results on modelling a skin spectroscopy setup.

II. METHODS

A. Quasi-optical modelling

It has been demonstrated that the tool developed in [9], [10] is capable of accurately modelling entire free-space measurement setups with large beam waist and performing the de-embedding of slab S-parameters required for permittivity extraction.

A similar approach is applied here to model a new configuration for reflection measurement of a multilayer slab system under oblique incidence. In this setup, shown in Fig. 1, only the reflected power is measured. Consequently, the measured and calibrated transmission parameter corresponds to the reflection parameter of the sample under test (a slab stack here). Two setups are proposed: the first (Fig. 1a) uses a paraxial beam incident on the dielectric slabs while the second focuses the beam on the outer surface of the sample to characterise (Fig. 1b). The ultimate goal is to concentrate the beam onto a small area of the sample to enable imaging of that surface.

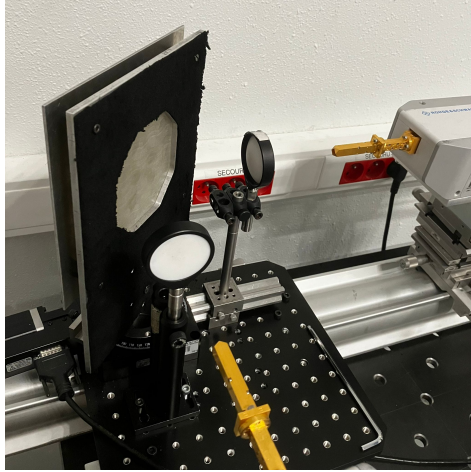
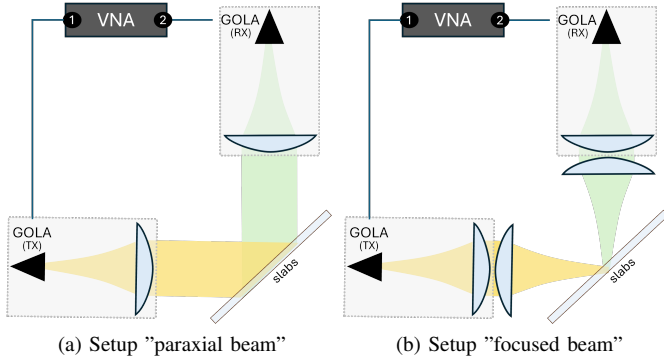

(c) Installed setup "paraxial beam", with a 12.815-mm slab of rexolite

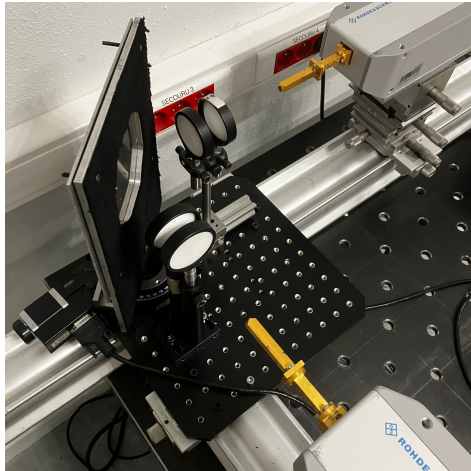

(d) Installed setup "focused beam", with a 1.125-mm slab of glass in front of a reflective surface

Fig. 1. Measurement bench operating in the J-band (220-330GHz), in the large GB waist configuration, and under oblique incidence of 45° .

The simulation workflow is identical regardless of the setup configuration and is shown in Fig. 2, where GBE refers to Gaussian Beam Expansion and GBT to Gaussian Beam Tracking, both described in [9]. The electric field from a diagonal horn (TX1) is decomposed into a series of vectorial Gaussian

beams (GBE). These beams are then tracked through the quasi-optical system. The collection of incident and generated beams models the field propagation within the system (GBT), and the total field of interest is obtained by summing the contributions of each beam at the considered points, which in our case are the points located at the horn aperture of port 2. A modal decomposition of the computed field at the aperture (RX2) yields the transmission parameter. To ensure accuracy, the GBE and GBT operations are performed between distant components that are not strongly coupled. Note that, in the case of complex samples, it is possible to combine this setup with a full-wave method, which enables the accurate modelling of the sample without requiring a full-wave modelling of the entire setup.

Two simulations are performed: the first simulates the THRU acquisition necessary for normalising the reflection parameters obtained from the second run.

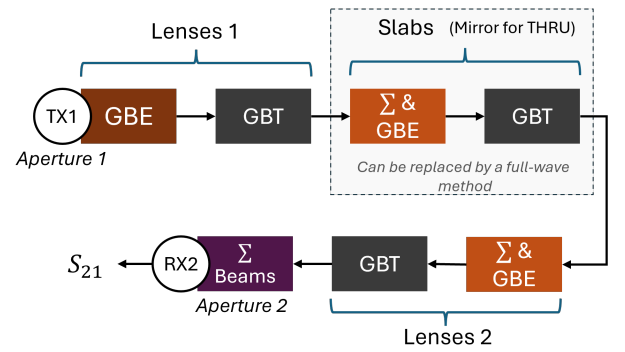

Fig. 2. Pipeline of the test bench's simulation.

B. Plane-Wave model of a dielectric slab under oblique incidence

The S-parameters simulated using the previously described method are compared to those obtained from a plane wave (PW) model.

A parallel-faced dielectric slab can be modelled using propagation matrices [11] or transmission line theory. This model assumes a plane wave incident on a material with infinite transverse dimensions. Thus, with γ as the propagation constant in the slab's medium of permittivity ϵ_r , and Γ as the reflection coefficient at the air-dielectric interface, we obtain the reflection and transmission coefficients for the dielectric slab of thickness h under normal incidence.

The behaviour of a plane wave at a planar interface depends on the inclination angle ψ and the beam's polarization: either TE (also referred to as S) or TM (referred to as P). In our configuration, the incident beam polarisation is TE. The reflection coefficient Γ at the interface follows Fresnel's laws. When the incident medium is air and the refracting medium has a permittivity of ϵ_r , the expression for Γ_{te} is given by

$$\Gamma_{te} = \frac{\cos(\psi) - \sqrt{\epsilon_r} \cos(\Psi)}{\cos(\psi) + \sqrt{\epsilon_r} \cos(\Psi)}, \quad (1)$$

with

$$\cos \Psi = \sqrt{1 - \frac{1}{\epsilon_r} \sin^2(\psi)}. \quad (2)$$

The reflection parameters $S_{11,th}$ can then be determined as a function of the angle ψ :

$$S_{11,th,te} = \frac{\Gamma_{te} (1 - \exp\{-2j\gamma h \cos(\Psi)\})}{1 - \rho^2 \exp\{-2j\gamma h \cos(\Psi)\}}. \quad (3)$$

III. RESULTS

In this section, we first evaluate the accuracy of the simulated transfer function by comparing it to experimental results and the commonly used plane wave (PW) approximation.

Figure 3 shows the simulated, analytic (i.e. PW model), and measured reflection parameters in amplitude and phase in J-band for the measurement setup shown in Fig 1c, corresponding to the configuration of Fig 1a for a large slab of rexolite. The sample panel being slightly misaligned relative to the reference reflector panel in the experimental setup, it is essential to adjust the model and simulation parameters accordingly. The misalignment is estimated to be 0.1 mm along the x-axis and 0.05 mm along the z-axis. We observe a better agreement between simulated and measured parameters than with the PW model. However, we can see that the simulation aligns more closely with the measurements at lower frequencies than at higher ones. This discrepancy could be attributed to minor misalignments in the experimental setup that are not accounted for in the simulation. Addressing such misalignments would be an interesting direction for future works.

Figure 4 shows the simulated, analytic (i.e. PW model), and measured reflection parameters in amplitude and phase in J-band for the same measurement setup for a 1.125 mm-thin slab of glass. We can observe that, for this configuration and material, the PW model is almost as close to the measurement as the simulation, indicating that the impact of using a paraxial Gaussian beam could be neglected for this material. We attribute this to the higher loss of the material (extinction coefficient $\kappa = 0.0225$) with respect to the rexolite. Further investigations should also be done in this direction.

Since the skin is highly lossy, it can be expected that no significant effects will be observed when using a skin sample alone. However, the sample is often placed on a substrate, which has very low losses. In this case, effects on the reflection parameter can be expected. Moreover, skin spectroscopy requires the use of a focused beam, such as in the configuration of Fig 1b.

The next step toward approximating a skin spectroscopy setup is to consider a focused beam and a multi-layer scenario. As an initial and highly simplified approximation, we assume a perfectly reflective material with a glass slide positioned in front. As a very rough first approximation, we consider a perfectly reflective material over which a glass slide is placed. It is particularly challenging in experiments to ensure that the

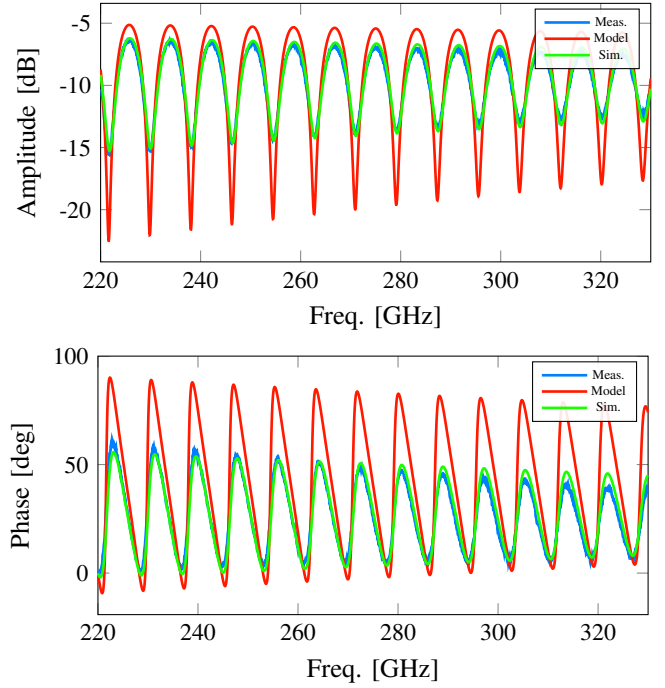

Fig. 3. Reflection parameters of the dielectric slab of rexolite (mean $\epsilon_r = 2.5371 - 0.00224j$) obtained from the simulation, the PW model, and the measurements.

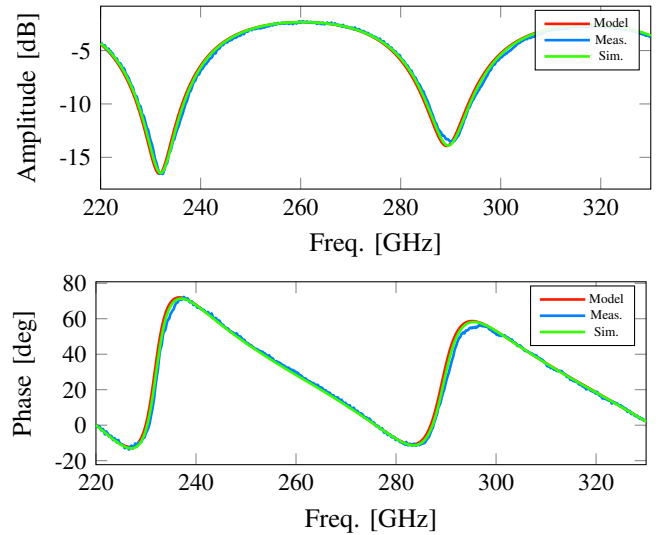

Fig. 4. Reflection parameters of the dielectric slab of glass (mean $\epsilon_r = 5.9292 - 0.10852j$) obtained from the simulation, the PW model, and the measurements.

two layers are perfectly adhered to each other. As a result, a small air gap is typically present between each layer.

A three-layer simulation, sample-air-PEC, was therefore performed and compared to a measurement on the setup in the focused configuration. As shown in Picture 5, a good agreement is found by using an air gap of 0.6 mm between the glass and the reflective surface. The air gap plays a significant role and must be carefully accounted for and estimated to ensure

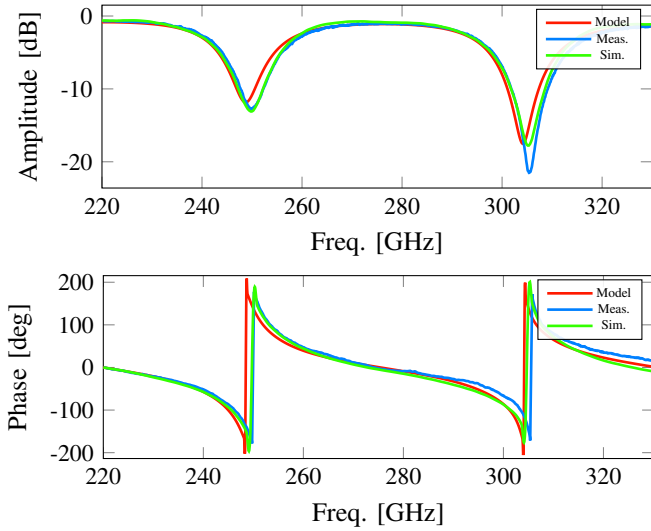

Fig. 5. Reflection parameters of a glass-air-PEC system (average $\epsilon_{r, glass} = 5.9292 - 0.10852j$) obtained from simulation, the PW model, and an experimental measurement. The air gap between the glass and the reflective material is estimated to be approximately 0.6 mm.

accurate extraction of permittivity. Moreover, the alignment of this setup is critical when working with focused beams, as even a slight misalignment can cause the focused waist to fall partly outside the aperture surface.

Next, we provide preliminary numerical simulations are performed to model a continuous-wave (CW) skin spectrometer, illustrating how this simulated transfer function can potentially enhance skin permittivity extraction. The skin is modelled as a single layer slab of thickness 1 mm and permittivity following the double Debye model [1], defined as follows:

$$\epsilon_r(\omega) = \epsilon_\infty + \frac{\epsilon_s - \epsilon_2}{1 + j\omega\tau_1} + \frac{\epsilon_2 - \epsilon_\infty}{1 + j\omega\tau_2}, \quad (4)$$

where the model's parameters are defined as $\tau_1 = 10$ ps, $\tau_2 = 0.2$ ps, $\epsilon_\infty = 3$, $\epsilon_s = 60$, and $\epsilon_2 = 3.6$. Note that the skin is placed on a single glass layer of permittivity $\epsilon_r = 5.9292 - 0.10852j$ and thickness 1 mm to mimic an experimental setup. Figure 6 shows the normalized magnitude of the total electric field propagating through the full spectrometer, showing the ability of the simulated data to reproduce real-world measurements when compared to traditional methods.

IV. CONCLUSION

This paper presented a pipeline for simulating reflection S-parameters of a complete quasi-optical setup. The results highlight the potential of this approach to enhance the precision of permittivity extraction in THz and sub-THz frequencies, particularly in applications involving localised permittivity extraction under oblique incidence, such as skin spectroscopy.

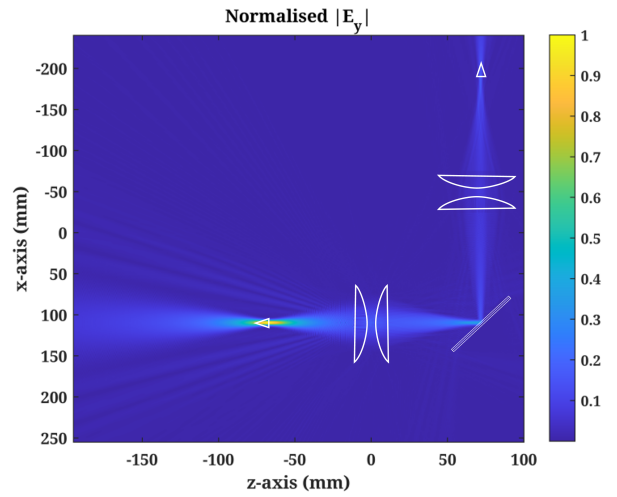

Fig. 6. Normalized magnitude of the out-of-plane electric field along the skin spectrometer at 300 GHz for the configuration "focused beam".

REFERENCES

- [1] J. Wang, H. Lindley-Hatcher, X. Chen, and E. Pickwell-MacPherson, "THz sensing of human skin: a review of skin modeling approaches," *Sensors*, vol. 21, no. 11, p. 3624, 2021.
- [2] B. Xue, J. Tuomela, K. Haneda, C. Icheln, and J. Ala-Laurinaho, "Permittivity characterization of human skin based on a quasi-optical system at sub-THz," *arXiv preprint arXiv:2405.11863*, 2024.
- [3] D. Bourreau, A. Peden, and S. Maguer, "A quasi-optical free-space measurement setup without time-domain gating for material characterization in the W-band," *Instrumentation and Measurement, IEEE Transactions on*, vol. 55, pp. 2022 – 2028, 01 2007.
- [4] L. R. Petersson and G. S. Smith, "An estimate of the error caused by the plane-wave approximation in free-space dielectric measurement systems," *IEEE Transactions on Antennas and Propagation*, vol. 50, no. 6, pp. 878–887, 2002.
- [5] M. Mrnka, R. Appleby, and E. Saenz, "Accurate s-parameter modeling and material characterization in quasi-optical systems," *IEEE Transactions on Terahertz Science and Technology*, vol. 12, no. 2, pp. 199–210, 2022.
- [6] P. Kužel, H. Němec, F. Kadlec, and C. Kadlec, "Gouy shift correction for highly accurate refractive index retrieval in time-domain terahertz spectroscopy," *Optics Express*, vol. 18, no. 15, pp. 15 338–15 348, 2010.
- [7] P. Koleják, K. Postava, M. Mičica, P. Kužel, F. Kadlec, and J. Pištora, "Experimental gouy phase shift compensation in terahertz time-domain spectroscopy," *Photonics and Nanostructures-Fundamentals and Applications*, vol. 31, pp. 129–133, 2018.
- [8] Y. Zhang, J. Zhang, Y. Zhou, C. Gao, Y. Gao, and E. Li, "Correction of complex permittivity inversion in free-space gaussian beam reflection model," *IEEE Transactions on Antennas and Propagation*, vol. 69, no. 10, pp. 6712–6722, 2021.
- [9] G. Gaudin, D. Bourreau, C. Henry, and A. Peden, "Modeling of quasi-optical systems and measurements with a cobot in the J-band," in *2024 18th European Conference on Antennas and Propagation (EuCAP)*. IEEE, 2024, pp. 1–5.
- [10] G. Gaudin, A. Peden, C. Henry, and D. Bourreau, "High frequency modeling of a quasi-optical characterization bench," in *42nd ESA Antenna Workshop*.
- [11] S. J. Orfanidis, *Electromagnetic Waves and Antennas*. Rutgers University, 2002, available online: <https://ecweb1.rutgers.edu/orfanidi/ewa/ch5.pdf>.