



**HAL**  
open science

## A LMI-based observer for induction motor

C. Darengosse, Philippe Chevrel, I. Souleiman, S. Siala

► **To cite this version:**

C. Darengosse, Philippe Chevrel, I. Souleiman, S. Siala. A LMI-based observer for induction motor. ECC'99, 5th European Control Conference, 1999, Karlsruhe, Germany. hal-01317370

**HAL Id: hal-01317370**

<https://imt-atlantique.hal.science/hal-01317370v1>

Submitted on 8 Jul 2021

**HAL** is a multi-disciplinary open access archive for the deposit and dissemination of scientific research documents, whether they are published or not. The documents may come from teaching and research institutions in France or abroad, or from public or private research centers.

L'archive ouverte pluridisciplinaire **HAL**, est destinée au dépôt et à la diffusion de documents scientifiques de niveau recherche, publiés ou non, émanant des établissements d'enseignement et de recherche français ou étrangers, des laboratoires publics ou privés.



Distributed under a Creative Commons Attribution 4.0 International License

# A LMI-Based Observer for Induction Motor

C. DARENGOSSE\*, P. CHEVREL#, I. SOULEIMAN GUELLE\* and S. SIALA\*

\* Laboratoire Atlantique de Recherche en Génie Electrique "GE 44"  
Bd. de l'Université - B.P. 406  
44600 Saint Nazaire – France  
Fax: +(33) 02-40-17-26-18 and e-mail: cedric@large.crttsn.univ-nantes.fr

# Institut de Recherche en Cybernétique de Nantes  
1, rue de La Noë  
44072 Nantes Cedex 3 – France

**Keywords:** LPV Observer, Induction Motor, Linear Matrix Inequality, H-infinity.

## Abstract

A LMI-based approach is proposed to design a quadratically stable flux observer for an induction motor. The resulting observer is a parametrically varying dynamic system that insures a  $L_2$ -gain attenuation between the exogenous input and the flux estimation error of the augmented plant. Its performance is evaluated and compared with those of the Verghese observer.

## 1 Introduction

The induction motor has very appealing properties. Contrary to the D.C. motor, which is based on mechanical contacts (brushes and commutator) between rotor and stator, the induction motor makes use of alternative supply of the stator windings to set up a rotating magnetic field, inducing currents in the rotor (closed) windings, hence providing a torque.

Consequently, the induction motor has relatively low cost and very good reliability and ruggedness. It is increasingly used in industrial applications, for these reasons. The counter-part is that the induction motor control is more difficult for two reasons: the model is non linear and some useful physical variables for feedback, the rotor flux for example, cannot easily be measured. This has motivated a growing amount of literature in the last years in the control community, which find this problem challenging. (Cf. references from [12] to [22])

The field oriented-control, **FOC**, ([11] [10]) is a popular approach as a basis for speed-control of the induction motor. The FOC makes use the Park's transformation to get a linear system. The next step consists classically in linear cascade control. In order to improve the performance of the regulation, many others methods have also been proposed, based on feedback linearization ([26] [21] [16]) or passivity [17]. Sometimes, adaptive schemes are proposed ([22] [20]).

In fact, whatever the control law considered, a good estimation of the rotor flux is always required.

The complexity of the flux observer design problem directly relies on the complexity of the model (non-linear of 6<sup>th</sup> Order) of the system. More over, the ideal observer has to be simple, high-performance and robust against parametric uncertainties. Actually, the simplest version is often used. It consists in an open-loop observer ([10] [15]) which estimates the flux from the current measurements. The convergence rate of such observer cannot be tuned because it is imposed by the rotor time constant.

At least, three alternatives have been studied in order to design a flux observer with better properties. The first one, based on the linear control theory (Luenberger observer), has been proposed by Verghese [15] and is appreciated [14] for its simplicity and its proven quadratic stability. The second one makes use of feedback linearization theory [26] as Bornard who proposes a high gain observer [12], or sliding modes control theory as in [13]. Such methods may bring difficulties to manage the compromise between noise and parameters sensitivity. Lastly, some authors ([18] [19]) proposed to use an extended Kalman filter to estimate the flux. Such an approach seems to work well in practice but with a big amount of computations.

The aim of this paper is to propose a robust flux observer design for induction drives. By construction, it will be quadratically stable and will satisfy an  $L_2$ -gain performance constraint. It will be found as a linear parameter-varying, **LPV**, dynamic system, where the varying-parameter is the motor rotor speed, by using a linear matrix inequality, **LMI**, approach ([7] [8] [9] [1] [2] [5]). The study is organized as follows: a standard gain scheduling problem and its solution in term of LMI constraint are reviewed in the second section. In the third section, an appropriate model of the system for the problem considered is given. The fourth section reports the observer design (following the second section) and analysis comparatively to the Verghese Observer.

## 2 L<sub>2</sub>-gain LPV Control

We consider, in the following, parameter dependant continuous-time system defined by the equation (1).

$$\left\{ \begin{array}{l} \begin{array}{l} \dot{x} \\ z \\ y \end{array} = \overbrace{\begin{bmatrix} A(\delta(t)) & B_1(\delta(t)) & B_2(\delta(t)) \\ C_1(\delta(t)) & D_{11}(\delta(t)) & D_{12}(\delta(t)) \\ C_2(\delta(t)) & D_{21}(\delta(t)) & 0 \end{bmatrix}}^{M(\delta(t))} * \begin{array}{l} x \\ w \\ u \end{array} \end{array} \right. \quad (1)$$

$x \in \mathbb{R}^n \quad w \in \mathbb{R}^{n_1} \quad u \in \mathbb{R}^{n_2} \quad z \in \mathbb{R}^{p_1} \quad y \in \mathbb{R}^{p_2} \quad \delta(t) \in \mathbb{R}^r$

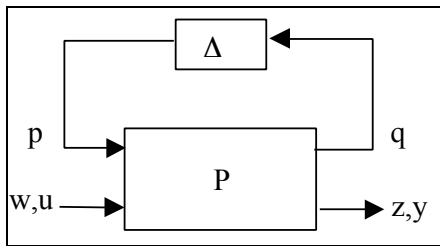
Where  $x$  is the state vector,  $u$  the control input,  $w$  the disturbance input,  $y$  the measured output and  $z$  the regulated output.  $\delta(t)=[\delta_1, \dots, \delta_r]^T$  is a vector of time-varying parameters assumed to be measured in to real-time and belonging to a polytopic set  $P_\Delta$  defined by its vertices  $\bar{\delta}_1, \dots, \bar{\delta}_v$ . Besides the matrices  $A(\cdot)$ ,  $B(\cdot)$ ,  $C(\cdot)$ ,  $D(\cdot)$  have a rational dependency on each parameter.

It is well known ([24][25]) that a linear fractional representation, **LFR**, exists for such a system. In other terms, there exists constant matrices  $A, B_w, B_u, \dots$  such that:

$$M(\delta) = \begin{bmatrix} A & B_w & B_u \\ C_z & D_{zw} & D_{zu} \\ C_y & D_{yw} & D_{yu} \end{bmatrix} + \begin{bmatrix} B_p \\ D_{zp} \\ D_{yp} \end{bmatrix} \Delta(t) * (I - D_{qp} \Delta(t))^{-1} \begin{bmatrix} C_q \\ D_{qw} \\ D_{qu} \end{bmatrix} \quad (2)$$

Where  $\Delta(t) := \text{diag}(\delta_1(t) * I_{n_1}, \dots, \delta_r(t) * I_{n_r})$ .

Denoting by  $P$  the time domain operator corresponding to the transfer matrix relying input ( $w, u$ ) to output ( $z, y$ ) and by  $\Delta$  the operator defined by  $p=\Delta, q$ , we obtain the **LFR** drawn in figure (1).



**Figure 1:** LFR for LPV system

This kind of representation is interesting in that it splits the standard plant into two parts: a linear model ( $P$ ) and a time varying operator ( $\Delta$ ).

A parameter dependent dynamic feedback of the form  $u=F_u(K, \Delta) * y$ , which stabilizes the system (1) and ensures for the close-loop transfer from  $w$  to  $z$  a  $L_2$ -gain less than  $\gamma$  can be found by solving an appropriate **LMI** [23]. The problem of finding such a feedback is said to be the standard one for

**LPV** controller design. After recast, the problem of the flux observer design may be embedded in the standard problem described above with an additional simplification. The matrix  $D_{qp}$  used in the equation (2) is in that case equal to zero. Consequently, the **LFR** is necessary well posed and reduces to affine or polytopic systems. We can therefore use the following result of [1] [7].

### Assumption

- 1-  $B_2, C_2, D_{12}, D_{21}$ : are time invariant.
- 2-  $(A(\Delta), B_2)$  stabilizable and  $(A(\Delta), C_2)$  detectable.
- 3- the vertices of the polytopic system are given by (3).

$$\begin{pmatrix} \dot{x} \\ z \\ y \end{pmatrix} = \begin{pmatrix} A_i & B_{1i} & B_{2i} \\ C_{1i} & D_{11i} & D_{12i} \\ C_{2i} & D_{21i} & D_{22i} \end{pmatrix} \begin{pmatrix} x \\ \omega \\ u \end{pmatrix} \quad (3)$$

The first assumption allows a finite number of constraints in the following theorem. The second assumption is a necessary and sufficient condition to allow the quadratic stabilization of the polytopic **LPV** plant by an output feedback **LPV** controller.

### Theorem [1] [7]

Let  $N_{Ri}$  and  $N_{Si}$  be the null space of  $[B_{2i}^T; D_{12i}^T]$  and  $[C_{2i}; D_{21i}]$ . An output **LPV** feedback controller insuring a  $\gamma$  level performances, under quadratic stability constraint, exists if and only if exist two symmetric matrices  $R$  and  $S$ , semi-definite positive, solving the following LMI:

$$\left\{ \begin{array}{l} \begin{pmatrix} N_{Ri} & 0 \\ 0 & I \end{pmatrix}^T \begin{pmatrix} A_i R + R A_i^T & R C_i^T & B_i \\ C_i R & -\gamma I & D_{1i} \\ B_i^T & D_{1i}^T & -\gamma I \end{pmatrix} \begin{pmatrix} N_{Ri} & 0 \\ 0 & I \end{pmatrix} < 0 \quad i=1..r \\ \begin{pmatrix} N_{Si} & 0 \\ 0 & I \end{pmatrix}^T \begin{pmatrix} A_i^T S + S A_i & S B_i & C_i^T \\ B_i^T S & -\gamma I & D_{1i}^T \\ C_i & D_{1i} & -\gamma I \end{pmatrix} \begin{pmatrix} N_{Si} & 0 \\ 0 & I \end{pmatrix} < 0 \quad i=1..r \\ \begin{pmatrix} R & I \\ I & S \end{pmatrix} \geq 0 \end{array} \right. \quad (4)$$

Then, we need to construct  $P_{cl}$  as follows:

- Find full rank matrix  $M, N \in \mathbb{R}^{n \times k}$  such that  $MN^T = I - RS$ .

$$P_{cl} = \begin{pmatrix} S & I \\ N^T & 0 \end{pmatrix} \begin{pmatrix} I & R \\ 0 & M^T \end{pmatrix}^{-1}$$

Note that  $P_{cl}$  is a Lyapunov matrix proving the quadratic stability of the closed-loop system.

A polytopic feedback is then found by computing each controller vertex,  $Cv_{i_r}$ , as a feasible solution of the **LMI** (6).

$$C_{vi} = \begin{pmatrix} A_{ri} & B_{ri} \\ C_{ri} & D_{ri} \end{pmatrix} \quad (5)$$

$$\begin{pmatrix} A_{cli}^T(\Delta_i)P_{cl} + P_{cl}A_{cli}(\Delta_i) & P_{cl}B_{cli}(\Delta_i) & C_{cli}(\Delta_i) \\ B_{cli}^T(\Delta_i)P_{cl} & -\gamma I & D_{cli}^T(\Delta_i) \\ C_{cli}(\Delta_i) & D_{cli}(\Delta_i) & -\gamma I \end{pmatrix} < 0 \quad (6)$$

Where  $(A_{cli}, B_{cli}, C_{cli}, D_{cli})$  are the closed-loop system matrices.

**Remark:** The LMI given by (6) is in fact the LTV case extension of the well known bounded real lemma ([1] [4] [7]) for the Linear time-invariant systems, LTI. In the LTI case the previous theorem provides the suboptimal  $H_\infty$  feedback [5] problem.

### 3 Model of the induction motor

Let us consider a balanced three-phase sinusoidal system described by the variable  $(x_a, x_b, x_c, x_o)$ , which can represent currents as well as supply voltages or magnetic fluxes. With this assumption, the zero sequence component  $x_o$  is null while the others are given by:

$$\begin{cases} x_a(t) = A \cos(\omega t + \varphi) \\ x_b(t) = A \cos(\omega t + \varphi - \frac{2\pi}{3}) \\ x_c(t) = A \cos(\omega t + \varphi - \frac{4\pi}{3}) \end{cases} \quad (7)$$

Hence, the Concordia transformation ( $T_{32}$ ) allows to simplify the equations of the induction motor by writing them in the  $(\alpha, \beta)$  reference frame.

$$T_{32} = \sqrt{\frac{2}{3}} \begin{bmatrix} 1 & 0 \\ \frac{-1}{2} & \frac{\sqrt{3}}{2} \\ \frac{-1}{2} & \frac{-\sqrt{3}}{2} \end{bmatrix}, \quad T_{32}^T T_{32} = I_2 \quad (8)$$

Therefore, we have the following expression:

$$\begin{bmatrix} x_a \\ x_b \\ x_c \end{bmatrix} = T_{32} \begin{bmatrix} x_\alpha \\ x_\beta \end{bmatrix}, \quad \begin{bmatrix} x_\alpha \\ x_\beta \end{bmatrix} = T_{32}^T \begin{bmatrix} x_a \\ x_b \\ x_c \end{bmatrix} \quad (9)$$

The application of those transformations to rotor and stator electric equations leads to the dynamical electric model (10) of the induction motor (see [10] [11] for details). The system (10) is an LPV-plant if one considers the mechanical speed,  $\Omega$ , as an external time-varying parameter.

$$\begin{bmatrix} \dot{\Phi}_{ra} \\ \dot{\Phi}_{r\beta} \\ \dot{i}_r \\ \dot{i}_{sp} \end{bmatrix} = \begin{bmatrix} -\frac{R_r}{L_r} & -p\Omega & \frac{R_r}{L_r}M_{sr} & 0 \\ p\Omega & -\frac{R_r}{L_r} & 0 & \frac{R_r}{L_r}M_{sr} \\ \frac{R_r M_{sr}}{\sigma L_r L_r^2} & p\Omega \frac{M_{sr}}{\sigma L_r L_r} & -\gamma & 0 \\ -p\Omega \frac{M_{sr}}{\sigma L_r L_r} & \frac{R_r M_{sr}}{\sigma L_r L_r^2} & 0 & -\gamma \end{bmatrix} * \begin{bmatrix} \Phi_{ra} \\ \Phi_{r\beta} \\ i_r \\ i_{sp} \end{bmatrix} + \begin{bmatrix} 0 & 0 \\ 0 & 0 \\ \frac{1}{\sigma L_s} & 0 \\ 0 & \frac{1}{\sigma L_s} \end{bmatrix} * \begin{bmatrix} V_{sa} \\ V_{s\beta} \\ u \end{bmatrix} \quad (10)$$

$$\text{Where } \sigma = 1 - \frac{M_{sr}^2}{L_s L_r}, \quad \gamma = \frac{L_r^2 R_s + M_{sr}^2 R_r}{\sigma L_s L_r^2}.$$

$V_s$ : Stator voltage     $I_s$ : Stator current  
 $\Phi_r$ : Rotor flux     $\Omega$ : Rotor mechanical speed  
 $R_r, R_s$ : Rotor and stator resistance  
 $L_r, L_s$ : Rotor and stator inductance  
 $M_{sr}$ : Mutual Inductance     $p$ : Number of poles pairs

$$\text{We also denote: } |\Phi_r| = \sqrt{\Phi_{ra}^2 + \Phi_{r\beta}^2} \quad (10)$$

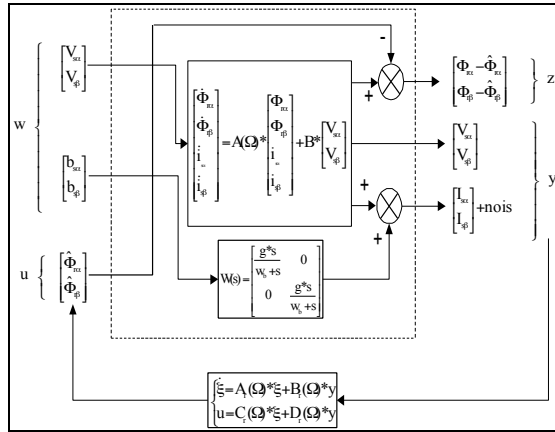
The rotor-speed dynamic is given by:

$$\dot{\Omega} = p \frac{M_{sr}}{J L_r} (\Phi_{ra} i_{sp} - \Phi_{r\beta} i_{s\alpha}) - \frac{f_v}{J} \Omega - p \frac{T_l}{J} \quad (11)$$

**Remark:** The global model is of sixth order including the rotor speed and position as state variables.

### 4 LPV observer synthesis

In order to design a flux observer for the induction motor, we proceed following the line of section two and make use of the algorithms provided the Matlab® LMI Control Toolbox [3]. Firstly, a LFR of the standard plant is found with  $\Delta(t) = \Omega(t) * I_n$  (see equation (1) and (2)). Secondly, the problem of flux estimation is encapsulated as a suboptimal  $L_2$ -gain problem as described in the theorem exposed in the second section. Let us consider the standard scheme of the figure 2. For the flux observer design problem, the regulated output are the fluxes estimation error, the measured outputs are the stator currents and the supply voltage while the control inputs are the estimated flux and the disturbance inputs are the supply voltage together with external noises.  $W(s)$  is a function weighting transfer allowing tuning the observer bandwidth. An LFR of the standard system can be easily found. Therefore, the observer is the dynamic feedback of the same order and LPV-structure than the standard system derived following the lines of the theorem 1 in the section two.



**Figure 2:** Standard System with Feedback

The design parameters,  $g$  and  $w_b$ , are chosen to fix the observer noise sensitivity and bandwidth. The choice of such a simple criterion to tackle with the problem of flux observer design may be discussed. In fact, it can be improved by taking into account more precisely the parameter uncertainties and disturbance of other origin. Assuming a good identification, the main source of uncertainty is the rotor resistance, which depends on the temperature into the motor. Therefore, it is possible to introduce additional disturbance inputs and/or regulated output in order to reduce the sensitivity of the design to that parameter. It is also possible to take into account the distortion introduced by the inverter switching between the desired supply voltage and the real ones.

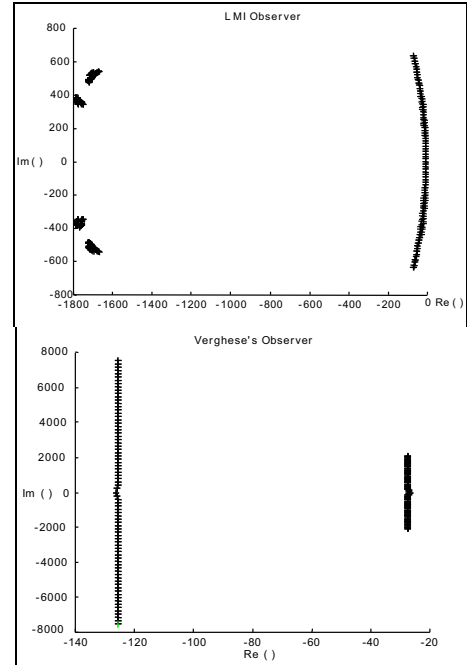
In practice, we found that the good robustness properties of the original design are not significantly improved using a more complicated criterion. Besides, it is not imperative to introduce the supply voltage distortion as a high frequency noise on the voltage input of the standard scheme, the motor behaving itself as a low pass filter.

Finally, the result obtained from the scheme of the figure 2 and the corresponding criterion are reported next and compared with the well appreciated Verghese observer [15]. The characteristics of the induction motors used for the simulation are the following:

- Electrical parameters:
  - $R_s=4.35 \Omega$
  - $R_r=2.48 \Omega$
  - $L_r=M_{sr}=0.176 \text{ H}$
  - $L_s=0.2 \text{ H}$
- Mechanical parameters:
  - $J=0.0054 \text{ kg.m}^2$
  - $p=2$
  - $F_v=0.0016 \text{ N.m.s.rd}^{-1}$

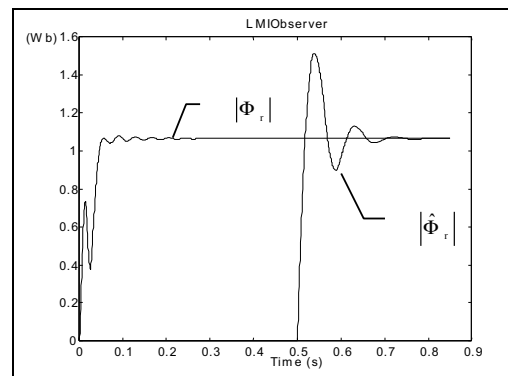
Besides the **LMI**-observer design parameters have been tuned to:  $g=5e-3$  and  $w_b=2000 \text{ rd/s}$ . Those values allow to fix the observer bandwidth to  $1800 \text{ rd/s}$  and the observer noise sensitivity to  $-120\text{db}$  (in high frequency).

The root locus of the **LMI** and Verghese observers parameterized depending on the rotor speed is drawn in the figure (3). It shows a different strategy in the closed-loop pole placement. The root locus also shows that the **LMI**-observer is better damped than the Verghese observer.

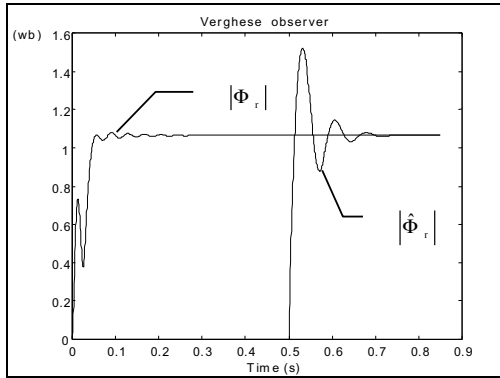


**Figure 3:** Roots locus

In order to appreciate the convergence rate of the estimated flux to the true value, a first test (figure 4a and 4b) has been performed using an open-loop scheme. The motor is supplied with a three phases sinusoidal voltage of  $50 \text{ Hz}$  and it is disturbed by a constant load torque. After the starting phase, the flux observer runs from null initial conditions. Both observers have comparable performances in terms of damping and time response. In less than  $0.2$  seconds, the flux estimation error converges to zero. Despite the difficulty of the test performed (nominal speed) the response is sufficiently well damped.

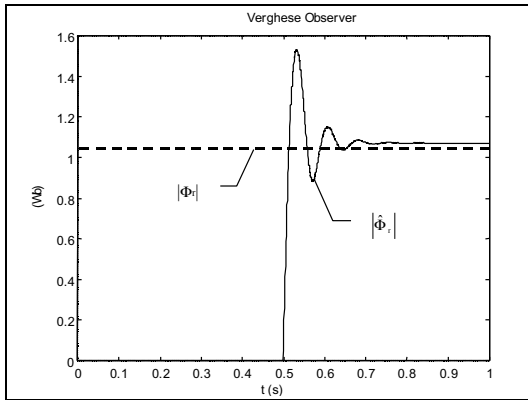


**Figure 4a:** Time Response :  $|\Phi_r|$ ,  $|\hat{\Phi}_r|$

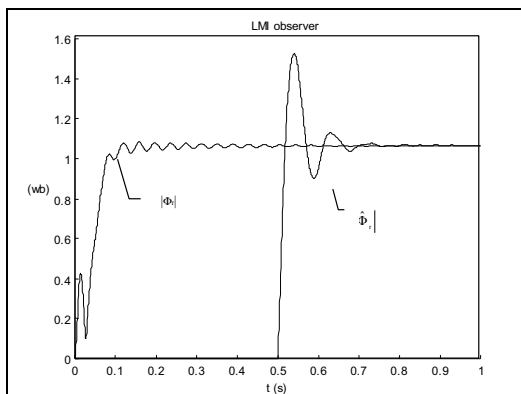


**Figure 4b:** Time Response :  $|\Phi_r|$ ,  $|\hat{\Phi}_r|$

A second test is performed in order to appreciate the filtering and robustness property of those observers. The simulation is performed with white noise on current measurement and a variation of 50% on the rotor resistance  $R_r$ . The figure (5) show that the noise is better filtered in the LMI-observer case. It is also shown that the LMI-observer is the most robust in term of static estimation error for the flux modulus.



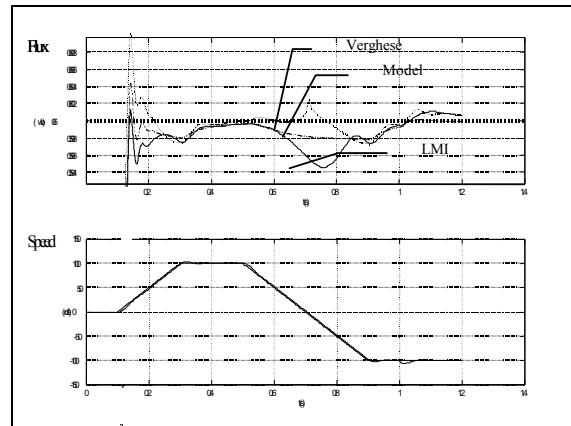
**Figure 5b:** Time Response :  $|\Phi_r|$ ,  $|\hat{\Phi}_r|$



**Figure 5b:** Time Response :  $|\Phi_r|$ ,  $|\hat{\Phi}_r|$

Others simulations have been performed to show the load torque influence in presence of rotor-resistance uncertainties. For both observers, the estimation error is non zero.

At last, the two observers have been tested for a particular speed profile of the motor (Cf. figure 6). For that purpose, a field-oriented controller based on classical (open loop) flux observer is used for speed control. So, the LMI and Vergheze observers are not used for feedback. Taking into account the very dilated flux scale, one can see the good performances both observers. The larger deviation (which remains very small) happened as expected when crossing the null speed.



**Figure 6:** Speed Regulation

## 5 Conclusions

After noticing that the induction motor model may have a linear fractional representation in a particular referential, a new approach, LMI-based, has been proposed to design a quadratically stable flux observer. The observer is a parametrically varying dynamic system, which insures  $L_2$ -gain attenuation between the exogenous input and the flux estimation error of the standard system. Its performances have been evaluated and compared with those of Vergheze observer. At the present we develop a more elaborate criterion to still improve the performance and the robustness against resistances variation. The next step consists to rigorously discretize this LPV observer in order to implement it with minimal amount of computation.

Further works may also include the reduction of the conservatism of the proposed method by taking into account the limited speed variation rate capability of the motor.

## 6 References

- [1]: S. Boyd, L. El Ghaoui, E. Feron and V. Balakrishnan "L.M.I. in system and control theory". SIAM Studies in applied mathematics (1994).

- [2]: J. Doyle, A. Packard and K. Zhou. "Review of LFT's, LMI's and  $\mu$ ". In Proc. IEEE CDC, vol. 2 p1227-1237 (1991).
- [3]: P. Gahinet, A. Nemirovsky, A. J. Laub and M. Chilali. "L.M.I. Control Toolbox". Mathworks Inc. (1995)
- [4]: C. Scherer. "The Riccati Inequality and State-Space  $H_\infty$  Optimal Control". Ph. D. Würzburg University. (1990)
- [5]: P. Gahinet and P. Apkarian. "A linear matrix inequality approach to  $H_\infty$  control". Int. J. of Robust and Non Linear Control, vol. 4 p421-448 (1994).
- [6]: T. Iwasaki and R. E. Skelton. "All controllers for the general  $H_\infty$  control problem: L.M.I. existence conditions and state space formulas". Automatica, vol. 30 N°8 p1307-1317 (1994).
- [7]: P. Apkarian and P. Gahinet. "A convex characterization of gain-scheduled  $H_\infty$  controllers". IEEE Trans. on Auto. Control, vol. 40 N°5 p 833-864 (1995).
- [8]: P. Apkarian, P. Gahinet, and G. Becker. "Self-scheduled  $H_\infty$  control of linear parameter-varying systems: a design example". Automatica, vol. 31 N°9 p. 1251-1261 (1995).
- [9]: G. Becker and A. Packard. "Robust performance of linear parametrically varying system using parametrically dependent linear feedback". System and Control letters, vol. 23 p205-215 (1994).
- [10]: J. P. Caron and J. P. Hautier. "Modélisation et commande de la machine asynchrone" Editions Technip (1995)
- [11]: W. Leonhard. "Control of electric drives". Springer-Verlag (1985).
- [12]: G. Bomard and H. Hammouri. "A high gain observer for a class of uniformly observable systems". In Proc. IEEE CDC p1494-1496 (1991).
- [13]: S. Sangwongwanich, T. Yonemoto, T. Furuhashi and S. Okuma. "Design of sliding observer for estimation of rotor flux induction motors". Electrical Engineering in Japan, vol. 110 N°6 p279-288 (1988).
- [14]: P. Martin & P. Rouchon. "Two remarks on induction motor". IMACS Multiconférence Lille p76-79 (1996).
- [15]: G. C. Verghese and S. R. Sanders. "Observers for flux estimation in induction machines". IEEE Trans. on Auto. Control, p85-94 (1988).
- [16]: M. Bodson, J. Chiasson & R. Novotnak. "High performance induction motor control via Input-Output linearization". IEEE Control System, p.25-33 (1995).
- [17]: J. Niklasson R. Ortega and G. Espinosa-Pérez. "Passivity-Based control of Class of Blondel-Park transformable Electric Machines". IEEE Trans. on Auto. Control, vol. 42 N°5 (1997).
- [18]: E. Von Westerholt. "Commandes Non-linéaire de machine électrique". Thèse de Doctorat Université de Grenoble (1994).
- [19]: E. Von Westerholt, M. Pietrzak-David, and B. de Fornel. "Extended state estimation of non-linear modeled induction machine". In Proc of PESC (1992)
- [20]: T. Von Raumer, J.M. Dion and L. Dugard. "Adaptive Non-linear control of induction motor with flux-observer". IEEE Systems Man Cybernetic conference p5.84 –5.89 (1997).
- [21]: D. Kim; I. Ha and M. Ko. "Control of induction motor via feedback linearization with input/output decoupling". Int. Jour. of control, Vol. 51 N°4 p.863-883 (1990).
- [22]: R. Marino, S. Perasada and P. Valigi. "Adaptive Input-Output Linearizing control of induction Motor". IEEE Trans. on Auto. Control, vol. 38 N°2 (1993).
- [23]: G. Scorletti and L. El Gahoui. "Improved LMI conditions for gain scheduling and related problems". In Proc of IEEE CDC (1995).
- [24]: P. Chevrel. "Commande Robuste: Application à la régulation d'un groupe turbo-alternateur". Thèse de doctorat de l'Université de Paris XI Orsay (1993).
- [25]: L. El Gahoui and G. Scorletti. "Control of rational system using LFR and LMI". Automatica, vol. 32 N°9 p1273-1284 (1996).
- [26]: A. Isidori. "Non-linear control systems". Springer-Verlag (1989).

## 7 Appendix

The LFR of the standard system in respect to (2) and to the induction motor considerate:

$$\Delta(t) := \Omega(t) * I_2 \text{ and } P := \begin{bmatrix} A_1 & B_p & B_w & B_u \\ C_q & D_{qp} & D_{qw} & D_{qu} \\ C_z & D_{zp} & D_{zw} & D_{zu} \\ C_y & D_{yp} & D_{yw} & D_{yu} \end{bmatrix}$$

Where:

$$A_1 = \begin{bmatrix} -14.1 & 0 & 2.48 & 0 & 0 & 0 \\ 0 & -14.1 & 0 & 2.48 & 0 & 0 \\ 587.1 & 0 & -284.6 & 0 & 0 & 0 \\ 0 & 587.1 & 0 & -284.6 & 0 & 0 \\ 0 & 0 & 0 & 0 & -2000 & 0 \\ 0 & 0 & 0 & 0 & 0 & -2000 \end{bmatrix} \quad B_p = \begin{bmatrix} 0 & -2 \\ 2 & 0 \\ 0 & 83.33 \\ -83.33 & 0 \\ 0 & 0 \\ 0 & 0 \end{bmatrix}$$

$$B_w = \begin{bmatrix} 0 & 0 & 0 & 0 & 0 & 0 \\ 0 & 0 & 0 & 0 & 0 & 0 \\ 41.67 & 0 & 0 & 0 & 41.67 & 0 \\ 0 & 41.67 & 0 & 0 & 0 & 41.67 \\ 0 & 0 & 1 & 0 & 0 & 0 \\ 0 & 0 & 0 & 1 & 0 & 0 \end{bmatrix}$$

$$C_y = \begin{bmatrix} 0_2 & I_2 & -I_2 \\ 0_2 & 0_2 & 0_2 \end{bmatrix}$$

$$D_{yw} = \begin{bmatrix} 0_2 & 5e-3 * I_2 & 0_2 \\ I_2 & 0_2 & I_2 \end{bmatrix}$$

$$C_q = C_z = \begin{bmatrix} I_2 & 0_{2*4} \end{bmatrix}$$

$$D_{qw} = D_{zw} = B_u^t = 0_{2*6}$$

$$C_q = C_z = \begin{bmatrix} I_2 & 0_{2*4} \end{bmatrix}$$

$$D_{zu} = -I_2$$

$$D_{yp} = D_{yu}^t = 0_{2*4}$$

$$D_{qp} = D_{qu} = D_{zp} = 0_2$$